

Thank you for purchasing Crazy Taxi. Please note that this software is designed only for use with the Sega Dreamcast console. Be sure to read this instruction manual thoroughly before you start playing Crazy Taxi.



CONTENTS

BASIC CONTROLS	2
CRAZY MANEUVERING	4
MODE SELECTION MENU	5
ARCADE/ORIGINAL MODE	6
CRAZY BOX MODE	12
OPTIONS	15
RECORDS	16
SAVE & LOAD	17
CABBIES	18
CUSTOMERS	20

Crazy Taxi is a memory card compatible game [Visual Memory Unit (VMU) sold separately]. In order to save game files, the VMU to be used must have at least 23 memory blocks of free space available.

azy Taxi is a one-player game that can be played using either the Dreamcast Controller or the Rally Wheel (sold separately). Connect the controller to be used to Control Port A of the Dreamcast.



Dreamcast Controller

NOTE: To soft-reset using the Dreamcast controller and return to the title screen at any point during game play, simultaneously press and hold the **A**, **B**, **X**, **Y** and Start Buttons.

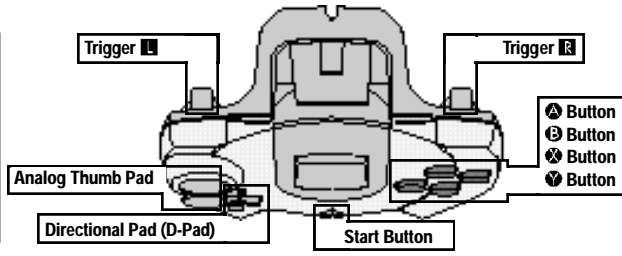



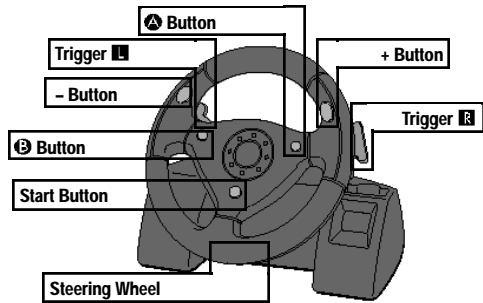











Rally Wheel (sold separately)







NOTE: To soft-reset using the Rally Wheel and return to the title screen at any point during game play, simultaneously press and hold the **A**, **B** and Start Buttons.

Refer to the following chart for a summary of the game controls:

	Action or Command	 Dreamcast Controller	 Rally Wheel
During Menu Selection	Moving the Cursor	Analog Thumb Pad/D-Pad	+ / - Button
	Enter	 Button	 Button
	Cancel/Return to the Previous Screen	 Button	 Button
	Item Selection	 Buttons	Steering Wheel
During Game Play	Game Start/Pause	Start Button	Start Button
	Character Selection	Analog Thumb Pad/D-Pad	Steering Wheel
	Steering	Analog Thumb Pad	Steering Wheel
	Accelerating	Trigger  R	Trigger  R
	Braking	Trigger  L	Trigger  L
	Drive Gear	 Button	+ Button
	Reverse Gear	 Button	- Button
Destination Reminder	 Button	 Button	

The controls described in this instruction manual describe usage of the Dreamcast Controller except where specified as describing usage of the Rally Wheel.

All button icons used in this instruction manual represent the default button settings.

CAUTION: Never touch the Analog Thumb Pad or the Triggers   (Rally Wheel = Steering Wheel, Triggers  ) while turning the Dreamcast power ON. Doing so may disrupt the controller initialization procedure and result in malfunction.

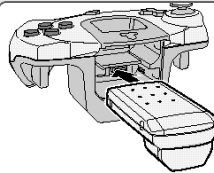

Using the Jump Pack:

When using the Jump Pack (sold separately) while playing Crazy Taxi, always be sure to insert the Jump Pack into Expansion Socket 2 of the Dreamcast Controller.

Learn how to perform these crazy maneuvers using different combinations of the **Steering Wheel**, **Accelerator**, **Brake** and **Drive/Reverse Shifting** commands.



CRAZY DASH - Propel the cab forwards with a burst of speed with this crazy move.

HOW TO EXECUTE

First, release both the accelerator and brake. Then, just after shifting into Drive, press the accelerator.



CRAZY DRIFT - Use this move to cause the cab to execute a sliding drift.

HOW TO EXECUTE

While moving forward, quickly shift into Reverse and back into Drive while cutting the Steering Wheel to the right or left.



CRAZY BACK DASH - Execute a hasty retreat with this speedy thrust in reverse.

HOW TO EXECUTE

Shift quickly into Reverse just after executing a **Crazy Dash**.



CRAZY BACK DRIFT - With this move the cab will continue to move in reverse after spinning 180°.

HOW TO EXECUTE

While moving forward, quickly shift into Drive and back into Reverse while cutting the Steering Wheel to the right or left.

Once the title screen appears, press the Start Button to display the mode selection menu. Use **↑** **↓** to select an item and press **Ⓐ** to enter your selection. Select **"EXIT"** or press **Ⓚ** to return to the title screen. For details on each of the modes available, refer to the corresponding page numbers listed below.



ARCADE

p. 6

In this game mode, play using the same course as the one featured in the Arcade version of Crazy Taxi.

ORIGINAL

p. 6

Select this game mode to play using the specially designed Dreamcast original course.

CRAZY BOX

p.12

Fine-tune your cab driving techniques by clearing each of these unique mini-games.

OPTIONS

p.15

Use this mode to modify various settings of the game.

RECORDS

p.16

Here you can view the records and rankings for each of the game modes.

SAVE & LOAD

p.17

Use this mode to save or load game data or perform name entry for player files.

th the Arcade and Original game modes have the same rules, content and menu. The only difference between these two modes is the course on which you play. After selecting either "ARCADE" or "ORIGINAL" from the mode selection menu, the following mode menu will be displayed. Use **↑** **↓** to select a mode and press **△** to enter your selection. Select "EXIT" or press **Ⓟ** to return to the title screen.

PLAY BY ARCADE RULES

Select this item to play according to the same rules as used in the Arcade version of Crazy Taxi. For details, see p. 9 – 11.

WORK FOR 3 MINUTES

Play freely for three minutes. Note that in this mode there are no time bonuses (see p. 11) available.

WORK FOR 5 MINUTES

Play freely for five minutes. Note that in this mode there are no time bonuses available.

WORK FOR 10 MINUTES

Play freely for ten minutes. Note that in this mode there are no time bonuses available.



Arcade Mode Menu



Original Mode Menu

While driving a customer



At the destination



GAME DISPLAY

- 1 **Game Time:** Once this time limit counts down to 0 the game is over.
- 2 **Directional Arrow:** This arrow shows the general direction of the destination.
- 3 **Fares:** The top figure is the **Total Earned Fare** and is a total of all fares earned. The bottom figure is the **Fare** for the current customer, which includes the base fare plus any tips earned, and will be added to the total earned fare once the customer is delivered to their destination.
- 4 **Crazy Manuevers & Combos:** All crazy maneuvers performed will appear here with a counter that tracks any successive combos made.
- 5 **Destination and Distance Counter:** A picture of the destination location and a distance counter indicating the distance to the destination, is displayed as the customer gets into the cab. Press to display this image while driving.
- 6 **Customer Time Limit:** If this time limit reaches 0 before reaching the destination, the customer will jump out of the cab without paying their fare.
- 7 **Gear Indicator:** Shows the gear, drive or reverse, currently selected.
- 8 **Time Bonus Indicator:** Indicates the time bonus earned for arriving early at the destination. The time bonus is only available when playing the "PLAY BY ARCADE RULES" of the arcade and original modes (see p. 11 for details).
- 9 **Ranking:** Shows your current ranking relative to the total rankings.

Pausing the Game

To pause the game and display the pause menu while playing in the Arcade, Original or Crazy Box modes, press the Start Button. Use to select a menu item and press to enter the selection. Press the Start Button to exit and continue playing.

EXIT: Select to exit the pause menu and continue playing.

RETRY: Select to restart the current game with the same driver in the same mode.

MENU: Select to exit the current game and return to the mode selection menu.

VIBRATION: If the vibration setting in the options menu is set to on, use to toggle this item ON/OFF. This item is only available when using a Jump Pack.



RIVER SELECTION

After selecting a game mode from either the Arcade or Original mode menu, the driver selection screen will be played.

Use **←** **→** to select a driver and press **▲** to enter your selection. If the counter reaches **0** before you enter a selection, the currently displayed driver will automatically be selected.



TIME OVER

Once the game time limit counts down to **0** the game is over and the results screen is displayed. If you can achieve a class ranking of **S**, the game ending and credits will play.



CUSTOMERS = The total number of customers delivered.

TOTAL EARNED = The total amount of money earned.

CLASS = This evaluation of your driving skills is based on a leveled assessment of your cumulative earnings. The available classes from the list down are **S, A, B, C, D, E** and **NO LICENSE**.

OUT OF RANKING = This placement is your ranking relative to the saved data. If your score is too low to place, **OUT OF RANKING** will appear.

NOTE: Rankings are only displayed when playing the "PLAY BY ARCADE RULES" of the Arcade and Original modes.

SAVE MENU

Use this menu to save the results of the game to a VMU. Use **↑** **↓** to select where to save the data and press **▲** to enter. If there are no player files set up in which to save data, select "**Register a new name**" and enter a new name to create a new file (see p. 17 for details).





GAME FLOW

Pick Up a Customer

man characters located in the city with a "\$" icon over their heads indicate potential customers waiting for a taxi ride. To pick up a customer the player must brake the cab to a complete stop within the **stop zone** - the circular outline that appears around the customer. The customer will then automatically approach and get in the cab.

FE: While waiting for the customer to get into the cab the game clock will continue to run but control of the cab is not possible.



Drive to the Destination

Once the customer gets in the cab the following 3 items appear on the game display: the "**Destination and Distance Counter**" appears briefly to the left of the cab, the "**Directional Arrow**" appears at the center top and the "**Customer Time Limit**" appears over the customer's head. It is your job to travel in the direction indicated by the arrow and deliver the customer to their destination before the customer time limit reaches 0. Provided you reach the destination in time, you will be paid the base fare as well as any tips given by the customer in appreciation of "**crazy**" driving (see "Fare System" and "Tips" p. 10).



Drop Off the Customer

To drop off the customer, brake the cab to a complete stop within the destination **stop zone**. Once stopped, the customer will automatically exit the cab and pay their fare (see p. 10) as well as any tips received.

FE: While waiting for the customer to get out of the cab the game clock will continue to run but control of the cab is not possible.



Do your best to repeat the above 3 steps as many times as possible before the game time counter reaches 0 to earn loads of crazy money!

ne different colors of each customer "\$" icon indicate e relative distance to the destination while the size of the **stop zone** around e customer indicates the relative difficulty involved getting there.



\$ ICON COLOR VARIATIONS

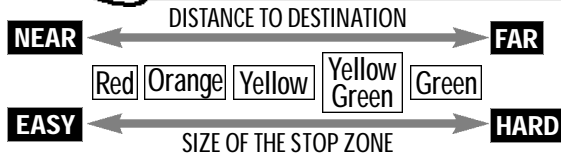

FARE SYSTEM



Time Limits and the Total Earned Fare

After getting into the cab, a number appears over the customer's head and begins to countdown. This is the customer time limit. If you are able to deliver the customer to their destination within this time limit you will be paid the **FARE**. This is then added to the **TOTAL EARNED FARE**. However, if you are unable to reach the destination before the timer reaches 0, the customer will jump out of the cab without paying.

Fares and Tips The three types of fares that can be earned are as follows:

BASE FARE

The base fare is calculated according to the distance of the destination. Once the customer gets in the cab, this amount will appear in blue under the total earned fare at the upper right of the game display.

TIPS

Tips are awarded to the cabbie whenever "crazy" maneuvers are executed in the course of driving the customer to their destination. Each tip is added to the base fare as earned.

BONUS FARE

When the cabbie arrives at the customer's destination, a bonus fare is converted from any time left over from the initial customer time limit. This is added to the base fare just before payment.

ARNING TIPS If the cabbie is able to "please" the customer by performing any of the following crazy maneuvers while delivering the customer to their destination they will be rewarded monetarily with tips. All tips are added to the base fare and then to the total earned fare upon arrival at the destination.

CRAZY JUMP

Use jump ramps or other similar elevation obstacles to become airborne.



CRAZY DRIFT

Sustain a sliding drift of the cab while turning.



CRAZY THROUGH

Stay in close to the other vehicles that you pass on the roads without hitting them.



COMBOS

If you are able to earn tips in succession, a running tally of the number of combos appears on the right of the display and continues until you collide with another vehicle. The more combos accumulated, the higher the tip value becomes, so do your best to rank up consecutive combos whenever and wherever possible! If you make a mistake or collide with another vehicle, the combo counter resets to zero.



TIME BONUS

When the cabbie delivers the customer to their destination, any leftover time from the customer time limit is converted into a **Time Bonus**, which is then added to the game time. The faster the cabbie arrives at the destination, the higher the bonus time awarded will be. The available time bonuses are:

SPEEDY

+5 seconds
(Green)

NORMAL

+2 seconds
(Yellow)

SLOW

No Bonus
(Red)

BAD

Appears when the customer jumps out of the cab without paying (Purple)

NOTE: Time Bonuses are only available in the "PLAY BY ARCADE RULES" of the arcade and original modes.

Use the various mini-games available in this mode to develop and improve your cab driving skills. Use **↑ ↓ ← →** to select a mode and press **Enter** to enter your selection. Select **"EXIT"** or press **Esc** to return to the title screen.



PLAYER FILE SELECTION

Use **← →** to select the name that represents your player file. If there are no player files available, select **"NEW ENTRY"** and press **Enter** to display the name entry screen. Enter a new name to create a new player file (see p. 17 for details).

CABBIE SELECTION

Use **← →** to select a cabbie and press **Enter** to enter your selection.

MINI-GAMES

Use **↑ ↓ ← →** to select a mini-game to play from among the displayed options. The rules and current rankings for the selected mini-game will be displayed to the right. Press the Start Button to play an advice box with tips on how to successfully complete the selected mini-game. Press the Start Button again to return to the Crazy Box selection menu. To play the selected game, press **Enter**.



The following mini-games are available at the start of play in the Crazy Box mode:



MINI-GAMES

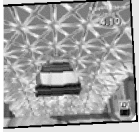

1-1

CRAZY JUMP

GOAL

Jump the cab off the jump ramp and land past the K point.



1-2

CRAZY FLAG

GOAL

Reach the flag located directly behind the cab on the other side of the beach within the allotted time limit.



1-3

CRAZY BALLOONS

GOAL

Burst all the balloons on the field within the allotted time limit.



2-1

CRAZY DRIFT

GOAL

Earn more than 15 total combos using the Crazy Drift within the allotted time limit.



2-2

CRAZY TURN

GOAL

Deliver the customer to their destination within the allotted time limit.



2-3

CRAZY BOUND

GOAL

Deliver the customer to their destination within the allotted time limit without falling into the ocean.



3-1

CRAZY RUSH

GOAL

Deliver all five customers to their destinations within the allotted time limit.



3-2

CRAZY JAM

GOAL

Deliver all three customers to their destinations, through heavily congested traffic, within the allotted time limit.



3-3

CRAZY POLE

GOAL

Deliver all the customers to their destinations within the allotted time limit.

in the options menu it is possible to modify the following game settings.
Use the **↑** **↓** to select an item and **←** **→** to modify the setting. Select **"EXIT"** or press **ⓧ** to return to the mode selection menu. The settings available for modification are as follows:

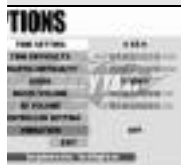

NOTE: Whenever you modify the options settings, the data will automatically be saved to the VMU when you exit the options menu.

TIME SETTING

Adjust the game time limit setting of the Arcade and Original modes for **"PLAY BY ARCADE RULES"** mode play.

TIME DIFFICULTY

Adjust the difficulty level of the game time setting of the Arcade and Original modes for **"PLAY BY ARCADE RULES"** mode play.

TRAFFIC DIFFICULTY

Adjust the difficulty level of the traffic setting of the Arcade and Original modes for **"PLAY BY ARCADE RULES"** mode play.

AUDIO

Set the preferred sound output to either **MONO** or **STEREO**.

MUSIC VOLUME

Adjust the volume setting for the background music.

SE VOLUME

Adjust the volume setting for the sound effects (SE).

TIME SETTING

Press **ⓧ** to display the controller settings screen and then select a controller setting type for the Dreamcast Controller or the Rally Wheel.

VIBRATION

Set to **"ON"** when using a Jump Pack while playing.
This setting is only activated when a Jump Pack is inserted into Expansion Socket 2 of the Dreamcast Controller.

re you can view all the records and rankings earned in every mode of the game. Use the **↑** **↓** to select an item and **↵** to enter your selection. Select **"EXIT"** or press **⏪** to return to the mode selection menu.



TOTAL RECORDS Select to view all the records for each player in all modes.

__ RECORDS Select a player file from among the displayed options to view the individual records for that player.

RECORDS MENU

Use **↑** **↓** to select a mode from the three options displayed on the left and **←** **→** to move forwards and backwards among pages. Select **"EXIT"** and press **⏪** to return to the Records menu.

AC

Arcade Mode Records

OR

Original Mode Records

CB

Crazy Box Mode Records



TOTAL RECORDS

license: The license class awarded (appears only with AC/OR records).

earned: Total amount of money earned (appears only with AC/OR records).

cabbie: The cab driver used.

name: The name of the player who earned this record (appears only with the TOTAL RECORDS).

ranking: The overall ranking for each successful clear (appears only with the CB records).

score: The actual score achieved (appears only in the CB records).

date: The date when the record entry was made (appears only with the __ records).

re you can save and load game data, enter a name to create a new player file or modify name of a current player file. Use the **↑** **↓** to select an item and press **Ⓜ** to enter your action. Select **EXIT** or press **Ⓟ** to return to the mode selection menu.

SAVE

Select to save all the current game settings and records to the VMU.

LOAD

Select to load previously saved data from the VMU.

ENTER NAME

Select to enter a new name or create a new player file. See below for details on how to enter a name.

DELETE NAME

Select to delete a player file. Use **↑** **↓** to select a file and press **Ⓜ**. When the deletion confirmation window appears, select **yes** to delete the file or **no** to cancel the deletion and return to the Save & Load menu.

MODIFY NAME

Select to edit the name of a player file. Use **↑** **↓** to select a file and press **Ⓜ**. See below for details on how to enter a name.



NAME ENTRY

Up to three characters can be used for each name entered to create a player file. Use **↑** **↓** to select a letter and **←** **→** to move the cursor. Press **Ⓜ** to enter the name.

Press **Ⓟ** to exit the name entry without entering a name.

A total of four player files can be created and maintained for saving game data.



NAME ENTRY

CEL
e
κ
le
ight
)"
ight
}



ense **1NOM155** = "I no miss"
ite # Meaning: "I don't make mistakes"



This wild guy is known to have a hot and quick temper. His only reason for becoming a taxi cab driver is that he considers being a cabbie the "coolest" profession. Axel always shows his customers a good time while driving his 60's era classic cab, earning big tips in the process! For him, cab driving is the ultimate career.

When he isn't working, Axel is usually trying to pick-up women, jamming with his punk band (bass and vocals) or participating in board sports like surfing or snowboarding. That said however, Axel's overly free-wheeling nature causes his band members to come and go on a regular basis and prevents him from maintaining decent relationships with women. Oh well, what's a guy to do? While he isn't perfect, his openhearted personality and naturally cheerful nature means he kind of grows on you. His most redeeming quality is that he is especially gifted at mediating whenever there is trouble or fighting amongst his many friends.

ENA
e
κ
nale
ight
)"
ight
?



ense **5EXY515** = "Sexy Sis"
ite # Meaning: You know what it means!



If Gena could be described in two words, without a doubt those words would be "cool & sexy". With a strong passion for cars, her reason for becoming a cab driver is simply, "Because I get to race around in my car all day!" While she's not so concerned with amusing her customers per se, she sure is timely. When asked if she'd be happier as a race car driver she just laughs and replies, "But it is such a rush to race through the traffic-laden streets... I could never give this up!"

When Gena is not working in her beloved cab, she can usually be found working on it. In fact, she spends nearly all her time and money performing extensive tune-ups, maintenance and cleaning. It is no surprise that most of the money she earns goes straight into her cab.

Despite her cab fixation, men are attracted to Gena's beauty. But she simply turns her nose up at any man who dares try to woo her. Clearly the sole object of her affection is her one and only cab!

is friendly & cheerful...
 S B.D. Joe. For him,
 ng a cab is a line of work
 hich he can "make peo-
 nappy". Happiest when he
 bring a smile to the face
 stomers, B.D. is a mas-



f both driving and conversational techniques.
 n when not driving his cab B.D. Joe is well
 vn as an accomplished performance artist.
 an throw together some lids and drum cans,
 using a pair of drumsticks, can blow you
 y with his musical prowess. His rhythms
 d so fine they put the "professional" musi-
 s to shame. His talent is such that he is often
 d why he doesn't perform professionally. But
 st laughs and says, "Making people smile is
 rd enough for me besides cabbng is too
 h fun to give up!"

ly B. D. Joe has taken up card tricks...why
 may ask? Because by doing so he can make
 ne's day anytime, anywhere.

is a handsome (in a melan-
 y sort of way) drifter who typ-
 the term "cool". He holds the
 ue distinction of being the
 nator of the "crazy" style. In
 outh, Gus was a wild and
 ntrrollable hooligan, selfish to
 jt. He hated to lose and



ys had to be # 1 at any and all cost. With a
 g fascination for all things new, Gus was nat-
 y drawn to that one unique trend that was
 y cool. With a knack for getting into some-
 y before it became popular, in the days when
 dn't even own a car he was riding in a nor-
 taxi when he had a flash of inspiration and
 ht an old junked out 1955 jalopy. Thus began
 crazy taxi trend.

n Gus isn't driving, he can usually be found
 ing cards. When the working day ends he
 ts with his poker buddies (whose members
 ge nightly) to while away the time playing
 r, blackjack and baccarat. A benefit of his
 bling is that Gus has come to understand the
 s of strategy, thereby mellowing his former
 re to win at all costs. Learning the why and
 of losing has made Gus a better person.



License
Plate #

2HOP260 = "To hop to go"
 Meaning: "Always ready to get crazy"

B.D.
JOE

Age

25

Sex

Male

Height

5'9"

Weight

165



License

Plate # ONLY777 = "Only 777"

Meaning: "Only aim for the big jackpot"

GUS

Age

42

Sex

Male

Height

5'8"

Weight

187

It's meet a few of the
any customers you'll
find throughout the city
waiting a crazy taxi
ride.



Cindy

This young
pretty college
student is a
psychology
major who
just loves
junk food!



Rachel

Currently work-
ing as a hospital
volunteer, this
young woman
dreams of
becoming a
doctor someday.



Grandma J

Keep your eyes
peeled for this
feisty ol' lady!
Those loud and
colorful pajamas
on Ms. Jessica
are sure hard to
miss.



Kim

This tourist is
always running
from one famous
landmark to another
with a video
camera in hand.
Smile!



Buzz

A hard-core lov-
ing punk rocker
who has a habit
of suddenly
appearing in the
most unexpected
of places!



Dan

A graduate student
of economics, Dan
is in the process of
writing his thesis
on the economical
impact of the fash-
ion industry on
world markets.



Biff

A baseball fanatic
who never misses a
game, Biff travels by
helicopter to watch his
favorite baseball team
in action whenever
they are playing away
games.



Pierre

A hopelessly romantic
young man who
spends all his time and
money chasing
women...another day
another date.

The following credits list the staff responsible for the localization marketing and manual production for the U.S. version of Crazy Taxi. Credits for the original development staff of the game are listed in the credits of the game itself.

SEGA of America
Product Development

Localization Producer

Osamu Shibamiya

Test Lead

Arnold Feener

Assistant Test Leads

Gabrielle Brown

Rick Ribble

Marketing

Product Marketing

Rick Naylor

John Golden

Public Relations

Heather Hawkins

Creative Services

Bob Schonfisch

Angela Santos

SEGA of Japan
Manual Production

Writer/Translator/DTP

Monika Hudgins

Design

Takashi Nishimura

Writer

Fumiaki Tomura

Supervisor

Kaoru Ichigozaki

Special Thanks

Lindsi Kimizuka

Todd Slepian